

Figure 6. MO/AO correlation diagram for cyclobutene.

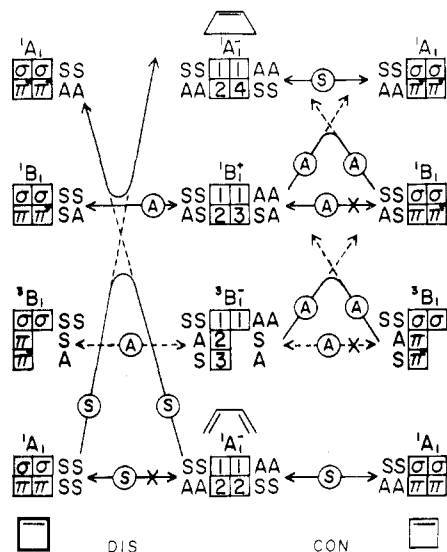

Figure 7. State- and orbital-symmetry correlation diagram for the butadiene-cyclobutene isomerization.

conrotatory isomerization. By orbital symmetry control, however, correlation is prohibited along the disrotatory path, so that the reactant and product states must correlate upward with excited states. Now the excited  $|^1A_1^- \rangle$  is a collective state with alternancy symmetry. However, in contrast to the allyl radical, both its components  $\begin{bmatrix} 1 & 1 \\ 2 & 4 \end{bmatrix}$  and  $\begin{bmatrix} 1 & 2 \\ 2 & 3 \end{bmatrix}$  have the same orbital

symmetry, so that  $|^1A_1^- \rangle$  can be assigned orbital symmetry unambiguously, making the construction of the correlation diagram relatively straightforward. The upward correlation of the two ground states gives rise to a zero-order state crossing which, since the states have the same symmetry, produces in first order an avoided crossing and predicts a barrier to the thermal disrotatory isomerization. For the triplet and the first excited singlet state a barrier is predicted for the conrotatory isomerization. These results are in general agreement with previous analyses.<sup>10,11</sup>

### Summary and Conclusion

We have presented a simple (linear) scheme for the construction of an MO/VB correlation diagram for  $\pi$  systems. Its central region lies closer to the "truth" as measured by a full CI calculation than do either of the two extremes. In particular, for MO states it improves generally the order and the spacing of the states, in part by resolving the degeneracies into states of different spin multiplicity and collective excitation. These corrections greatly improve the interpretation of structure, spectra, and reactivity. The correlation diagrams can be verified and extended by making full CI calculations with semiempirical Hamiltonians of the Hubbard or Pariser-Parr-Pople type.

We have found Gel'fand states to be extremely useful in the construction of the MO/VB correlation diagrams since they carry a highly pictorial unique label which identifies both the orbital configuration and the spin state. Gel'fand states are also quite useful for CI computation since they are basis vectors for the irreducible representations of the unitary group and since the Hamiltonian can be expressed as a second degree polynomial in the generators of the group<sup>3,13</sup> so the matrix elements can be evaluated algebraically. This unitary group formulation is spin free, conserves both particle number and spin, and is a viable alternative to the second quantized formulation of the many-body problem.

The author is happy to acknowledge financial assistance from the Robert A. Welch Foundation of Houston and technical and editorial assistance by Dr. T. L. Welsher.

(13) F. A. Matsen, *Int. J. Quantum Chem.*, 10, 525 (1976).

## Distinctive Coordination Chemistry and Biological Significance of Complexes with Macrocyclic Ligands

DARYLE H. BUSCH

*Evans Chemical Laboratory, The Ohio State University, Columbus, Ohio 43210*

*Received May 2, 1977*

Prior to the developments described herein, macrocyclic ligands were extremely rare species. The

Daryle H. Busch is Professor of Chemistry at The Ohio State University. He received the B.A. degree from Southern Illinois University in 1951 and the M.S. and Ph.D. degrees from the University of Illinois in 1952 and 1954, respectively. His research interests are in transition element chemistry and in the ways in which metal complexes affect chemical reactions, including catalysis and models for biological processes.

porphine ring of the heme proteins, the related natural macrocyclic complexes of magnesium, chlorophyll, and its derivatives, and the corrin ring of vitamin B<sub>12</sub> and closely related structures were well-known and had been studied extensively. However, the only established synthetic ligand of this kind was phthalocyanine, the pigment whose structure is closely related to that of porphine. Thus, even though many kinds of poly-

dentate chelating agents<sup>1</sup> were known and well understood, relatively simple macrocyclic ligands had not been available for study.

The occurrence in nature of large rings as ligands in such crucial and multiple roles as those spanned by the heme proteins, chlorophyll, and vitamin B<sub>12</sub> suggests that some advantages might be associated with this macrocyclic structure. Thus one can appropriately ask "what is special about macrocycles as ligands?". The question is not simply confronted in studies of the natural products because of the considerable complexity of the structures of those ligands. For example, the porphyrin ring is an aromatic dianion with an extensive  $\pi$  system, and its interactions with metal ions is complicated. Metal-donor  $\pi$  interactions prohibit the characterization of the electron density and energy states of the metal atom in simplest terms. The ligand is a powerful chromophore, so that d-d spectra are not observable in its complexes. Redox interactions are complicated by electron transfers that may involve the metal ion, the ligand, or both. The new synthetic macrocyclic ligands have provided the opportunity to define and elaborate those ways in which the cyclic nature of the ligand conveys special properties on its metal complexes.

The geometric consequences of the coordination of reactive ligands to a metal ion provided an early focus of research in these laboratories.<sup>2</sup> The several ligands coordinated to a metal ion are held in specific geometric orientations, and recognition of this fact led to the *coordination template hypothesis*.<sup>3,4</sup> It was suggested that the synthesis of new and interesting structures should be made possible by taking advantage of the orientation of molecules within its coordination sphere, before, during, and after some proposed reactions. Successful demonstrations of these relationships have produced many new coordinated macrocyclic ligands,<sup>5,6,7</sup> for example, eq<sup>3</sup> 1 and structure<sup>8,9</sup> I. A number of other

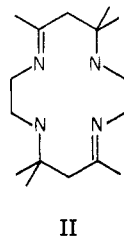
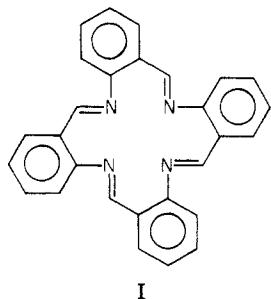
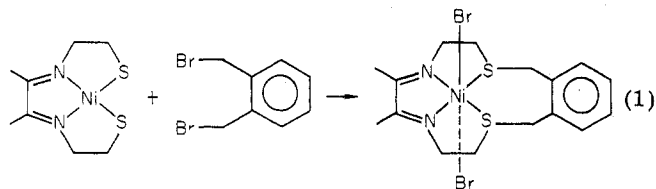

(1) H. A. Goodwin, "Chelating Agents and Metal Chelates", F. P. Dwyer and D. P. Mellor, Ed., Academic Press, New York, N.Y., 1964, Chapter 4.

(2) D. H. Busch, *Adv. Chem. Ser.*, No. 37, 1 (1963).

(3) M. C. Thompson and D. H. Busch, *J. Am. Chem. Soc.*, 86, 3651 (1964).

(4) E. Blinn and D. H. Busch, *Inorg. Chem.*, 7, 820 (1968).

(5) D. H. Busch, *Record Chem. Prog.*, 25, 107 (1964).

(6) D. H. Busch, *Helv. Chim. Acta*, Alfred Werner Commemoration Volume, 174 (1967).

(7) L. F. Lindoy and D. H. Busch, *Prep. Inorg. React.*, 6, (1971).

(8) G. A. Melson and D. H. Busch, *Proc. Chem. Soc. London*, 223 (1963).

early developments provided additional examples of synthetic macrocyclic ligands, as illustrated by Curtis's discovery of the cyclocondensation between methyl ketones and short linear  $\alpha,\omega$ -diamines (structure II).<sup>10-12</sup> The chemistry of complexes with macrocyclic ligands has since been extensively developed and is summarized in a number of reviews.<sup>5-7,13-17</sup>

Most of the macrocyclic ligands first developed were not ideally suited to studies directed toward elucidating the special advantages of the macrocyclic structure because of complications in their structures that result from the peculiar requirements of their synthesis. Tetraaza macrocycles would seem most appropriate for study because the knowledge gained might be most easily transferable to the understanding of the natural products. The tetramer of *o*-aminobenzaldehyde (structure I) and the condensation products of acetone and ethylenediamine (structures II) were not ideal because of unsaturation, in both cases, which might lead to metal-ligand  $\pi$  bonding. Further, the peripheral methyl groups, in the latter case, could add steric effects to any macrocyclic effects that might occur.

Despite these limitations, early studies suggested a number of ways in which macrocyclic ligands might impart unusual properties to their metal complexes. The ligand field strengths of a number of macrocyclic ligands appeared to be unusually high.<sup>18,19</sup> Also, synthetic and stereochemical studies suggested that the metal complexes might be unusually inert toward dissociation of the ligands. Two examples of the latter phenomenon will facilitate later discussion. Most of the known complexes of nickel(II) with amines are rapidly destroyed by strong aqueous acid, yielding the aquated metal ion and protonated amine. The behavior of the nickel(II) complex of the ligand having structure II stands in sharp contrast. The metal ion and ligand are not separated by strong acid. In fact, dilute (2 M) HNO<sub>3</sub> oxidatively dehydrogenates the ligand, producing a complex of a new macrocyclic ligand in which the metal-donor set retains its full integrity.<sup>20</sup> The second example involves the existence of chiral and diastereoisomers of, for example, the Ni<sup>II</sup> complex of structure II.<sup>21</sup> The chiralities of the secondary nitrogen atoms are conserved as a result of the great substitution inertness of the nickel(II) complex.

## A Prototypic Family of Macrocyclic Ligands

Bosnich and co-workers<sup>22,23</sup> first reported studies on complexes of a tetraaza macrocyclic ligand that is es-

(9) G. A. Melson and D. H. Busch, *J. Am. Chem. Soc.*, 86, 4834 (1964).

(10) N. F. Curtis, *Coord. Chem. Rev.*, 3, 3 (1968).

(11) D. A. House and N. F. Curtis, *Chem. Ind. (London)*, 1708 (1961).

(12) N. F. Curtis, Y. M. Curtis, and H. K. J. Powell, *J. Chem. Soc. A*, 1015 (1966).

(13) L. F. Lindoy, *Chem. Soc. Rev.*, 4, 421 (1975).

(14) *Struct. Bonding*, 16 (1973).

(15) J. Christensen, D. J. Eatough, and R. M. Izatt, *Chem. Rev.*, 74, 351 (1974).

(16) D. H. Busch, K. Farmery, V. Goedken, V. Katovic, A. C. Melnyk, C. R. Sperati, and N. Tokel, *Adv. Chem. Ser.*, No. 100, 44 (1971).

(17) D. St. Clair Black and E. Markham, *Rev. Pure Appl. Chem.*, 15, 109 (1965).

(18) G. R. Brubaker and D. H. Busch, *Inorg. Chem.*, 5, 2114 (1966).

(19) D. A. Rowley and R. S. Drago, *Inorg. Chem.*, 7, 795 (1967).

(20) N. F. Curtis, *Chem. Commun.*, 882 (1966).

(21) L. G. Warner, N. J. Rose, and D. H. Busch, *J. Am. Chem. Soc.*, 90, 6938 (1968); 89, 703 (1967).

(22) B. Bosnich, M. L. Tobe, and G. A. Webb, *Inorg. Chem.*, 4, 1109 (1965).

(23) B. Bosnich, C. K. Poon, and M. L. Tobe, *Inorg. Chem.*, 5, 1514 (1966).

pecially well suited to the characterization of those exceptional properties that may be associated with the cyclic nature of macrocyclic ligands. This ligand is 1,4,8,11-tetraazacyclotetradecane ([14]aneN<sub>4</sub>, structure III).<sup>24</sup> The ligand constitutes a cyclic counterpart to

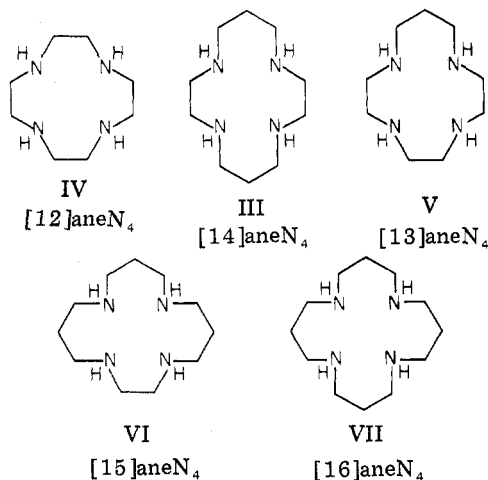

such common ligands as ethylenediamine, diethylenetriamine, and triethylenetetramine. The saturated nitrogens are relatively hard and interact with the metal ion only through  $\sigma$  bonds. It follows that the properties of [14]aneN<sub>4</sub> complexes should correspond to those of the most typical classic coordination compounds, deviating only in ways that reflect the cyclic structure of the ligand. Such complexes are relatively well described by simple bonding models. In much of the discussion that follows, [14]aneN<sub>4</sub> and its congeners are considered to be the ultimate prototypic macrocyclic ligands.

Having selected a prototype for macrocyclic ligands, it is appropriate to turn to a closely related question that bears directly on attempts to ascertain those effects that arise from the cyclic nature of such species. This has to do with identifying the structural parameter or parameters that would serve best as these goals are pursued. Ring size is such a parameter; it arises only when a structure is cyclic and its variation would be expected to produce relationships that clearly reveal the effects sought. Accordingly, an entire series of saturated tetraaza macrocycles ranging from 12 members through 16 members (structures III–VII) has been synthesized in these laboratories.<sup>25,26</sup> Only the ligands [14]aneN<sub>4</sub> and [12]aneN<sub>4</sub><sup>27</sup> had previously been reported.

The high-spin, six-coordinate nickel(II) ion<sup>26</sup> and low-spin, six-coordinate cobalt(III)<sup>28</sup> ions were chosen for careful evaluation of the effects of ring size on the metal–donor interaction. The application of the ligand field model to complexes with metal ions in common oxidation states has yielded the concept of a spectrochemical series which sequences the various ligating

Table I  
Spectrochemical Parameters<sup>26</sup> for the Complexes  
Ni([14–16]aneN<sub>4</sub>)Z<sub>2</sub> (in cm<sup>-1</sup>)

complex	$Dq^{xy}$	$Dq^z$
Ni([15]aneN <sub>4</sub> )Br <sub>2</sub>	1283	452
Ni([14]aneN <sub>4</sub> )Cl <sub>2</sub>	1480	379
Ni([15]aneN <sub>4</sub> )Cl <sub>2</sub>	1242	589
Ni([16]aneN <sub>4</sub> )Cl <sub>2</sub>	1116	510
Ni([15]aneN <sub>4</sub> )(N <sub>3</sub> ) <sub>2</sub>	1227	764
Ni([15]aneN <sub>4</sub> )(NCS) <sub>2</sub>	1202	908

atoms or groups in order of their donor ability toward a given metal ion. Implicit in this treatment is the notion that donor ability is essentially constant for any particular metal ion–donor group set.

Complexes of the general formulas *trans*-[Ni<sup>II</sup>(MAC)Z<sub>2</sub>] and *trans*-[Co<sup>III</sup>(MAC)Z<sub>2</sub>]Y were prepared<sup>26,28</sup> for the macrocyclic ligands III–VII except [12]aneN<sub>4</sub> (IV), which is too small to encompass these particular ions and only forms a *cis* complex.<sup>27</sup> For the most part, the axial ligands Z ranged over the anions Cl<sup>-</sup>, Br<sup>-</sup>, N<sub>3</sub><sup>-</sup>, and NCS<sup>-</sup>. Application of the ligand field model with full configuration interaction to the electronic spectral data on these complexes leads to parameters exemplified by those reported in Table I. The quantity  $Dq^{xy}$  measures the ligand field strength of the tetradentate tetraaza macrocyclic ligand, while  $Dq^z$  provides an indication of the axial ligand–nickel ion interaction.

The most striking result is the fact that  $Dq^{xy}$  varies strongly with ring size for a constant axial ligand. The effect is large, and the parameter ranges over some 25% of its value. This certainly is not consistent with the concept that a constant donor set (e.g., N<sub>4</sub>Cl<sub>2</sub>) should yield a constant ligand field. To examine this variation in ligand field strength with ring size in more detail, it is useful to compare the results with some reference value for saturated nitrogen donors bound to nickel(II). An analysis of available data suggests that donors of the kind present in [12–16]aneN<sub>4</sub> should exhibit  $Dq^{xy}$  values of approximately 1200 cm<sup>-1</sup>, and this is our reference value.<sup>26</sup> It follows that the ring that exhibits a  $Dq^{xy}$  value closest to 1200 cm<sup>-1</sup> behaves in a normal fashion. The complex *trans*-Ni([15]aneN<sub>4</sub>)Cl<sub>2</sub> fulfills this requirement since  $Dq^{xy} = 1242$  cm<sup>-1</sup> (Table I). This normal value of  $Dq^{xy}$  stands in contrast to the values observed for the parameter in the cases of the larger or smaller rings. The complex with the larger ring, *trans*-Ni([16]aneN<sub>4</sub>)Cl<sub>2</sub>, exhibits an abnormally low value of  $Dq^{xy}$  (1116 cm<sup>-1</sup>), while that with the smaller 14-membered ring exhibits an abnormally high value (1480 cm<sup>-1</sup>).

An embryonic rationale for these observations views the macrocyclic ligand as a stiff elastic band that encircles the metal ion and is bound to it at four points (the nitrogens).<sup>25–28</sup> Such a stiff elastic band would have a natural radius which would correspond to the metal–nitrogen distance in an undistorted structure. Normal behavior, in the spectrochemical sense, is observed when the ring is precisely the size that fits the specific metal ion with no deviation from its normal shape or size. If the stiff elastic band is too small, it must be stretched to accommodate the metal ion. This distortion exerts a force that serves to enhance the metal–donor interaction and, therefore, increase the magnitude of  $Dq^{xy}$ . If the stiff elastic band is too large,

(24) The correct names for these compounds are: [12]aneN<sub>4</sub>, 1,4,7,10-tetraazacyclododecane; [13]aneN<sub>4</sub>, 1,4,7,11-tetraazacyclotridecane; [14]aneN<sub>4</sub>, 1,4,8,11-tetraazacyclotetradecane; [15]aneN<sub>4</sub>, 1,4,8,12-tetraazacyclopentadecane; and [16]aneN<sub>4</sub>, 1,5,9,13-tetraazacyclohexadecane. In cases where it is important, locants can be carried in the abbreviation; e.g., [14]ane-1,4,8,11-N<sub>4</sub> has an isomer [14]ane-1,4,7,11-N<sub>4</sub>. For the derivation of the abbreviations see *J. Am. Chem. Soc.*, **94**, 3397 (1972), and *Inorg. Chem.*, **11**, 1979 (1972).

(25) L. Y. Martin, L. J. DeHayes, L. J. Zompa, and D. H. Busch, *J. Am. Chem. Soc.*, **96**, 4046 (1974).

(26) L. Y. Martin, C. R. Sperati, and D. H. Busch, *J. Am. Chem. Soc.*, **99**, 2968 (1977).

(27) J. P. Collman and P. W. Schneider, *Inorg. Chem.*, **5**, 1380 (1966).

(28) Y. Hung, L. Y. Martin, S. C. Jackels, A. M. Tait, and D. H. Busch, *J. Am. Chem. Soc.*, **99**, 4029 (1977).

Table II  
Ligand Field Parameters and Ideal M-N Distances<sup>28</sup>  
for *trans*-Co([13-16]aneN<sub>4</sub>)Cl<sub>2</sub><sup>+</sup>

ligand	$Dq^{xy}$ , cm <sup>-1</sup>	ideal M-N, Å	strain energy, <sup>a</sup> $\Delta H$ , kcal/mol
[15]aneN <sub>4</sub>	2750	2.01	19.7
[14]aneN <sub>4</sub>	2562	2.13	11.5
[15]aneN <sub>4</sub> , isomer II	2421	2.23	25.5
isomer I	2303	2.28	21.3
[16]aneN <sub>4</sub> , isomer II	2341	---	36.6
isomer I	2249	2.42	35.6

<sup>a</sup> Calculated using all parameters, including the Co-N stretching force constant.

it will tend to stretch the metal-donor linkages as they act to compress the ring. This causes a decrease in  $Dq^{xy}$ .

In view of the concept of these saturated aliphatic heterocyclic ligands as stiff elastic bands it seemed appropriate to develop a quantitative strain energy model for them. With the kind assistance of Kenneth Wiberg of Yale and Richard Boyd of Utah, suitable computer programs were obtained and subsequently adapted. The model was tested thoroughly by its application to complexes of bidentate and linear tetradentate ligands<sup>29</sup> before it was used to treat complexes with macrocyclic ligand.<sup>25,28</sup>

A particularly fascinating result of these calculations is the estimation of the (relative) natural metal ion site sizes for tetraazamacrocyclic ligands. It seemed likely that a minimum energy conformation might be found for the ligand arrayed as it would be in order to chelate (in a planar tetradentate fashion) but with no metal ion inside the ring. This was accomplished by initiating the calculation with a conformation appropriate to planar tetradentate chelation, but with the metal-nitrogen stretching force constant set equal to zero. The resulting values for the distance between the center of the ring and the center of a nitrogen atom (averaged if necessary) define the least strained metal-nitrogen distance for any given ring. We call it the *ideal M-N distance*.

Values for the ideal M-N distance appear in Table II along with  $Dq^{xy}$  values for the cobalt(III) complexes having the formula *trans*-Co([13-16]aneN<sub>4</sub>)Cl<sub>2</sub><sup>+</sup>. The complexes of [15]aneN<sub>4</sub> and [16]aneN<sub>4</sub> both exist as pairs of configurational isomers, and this subject will be treated shortly. It suffices to note here that isomers differ in their values of  $Dq^{xy}$  and in their ideal M-N distances. (An ideal M-N distance could not be evaluated for the less stable isomer derived from [16]aneN<sub>4</sub> because of extreme distortions from planarity.)<sup>28</sup>

Proceeding first in a manner similar to that applied to the nickel(II) data, a normal value for  $Dq^{xy}$  for the N<sub>4</sub>Cl<sub>2</sub> donor set for cobalt(III) has been established at 2530 cm<sup>-1</sup>.<sup>28</sup> From Table II, the 14-membered ring fits cobalt(III) best, i.e., in the least strained fashion ( $Dq^{xy} = 2562$  cm<sup>-1</sup>). The smaller ring generates a large value ( $Dq^{xy} = 2750$  cm<sup>-1</sup>), while the isomers of larger rings uniformly produce weakened ligand fields. Thus, the constrictive effect of small rings and the dilative effect of large rings is felt equally by both metal ions (Ni<sup>II</sup> and Co<sup>III</sup>).

(29) L. J. DeHayes and D. H. Busch, *Inorg. Chem.*, **12**, 1505, 2010 (1973).

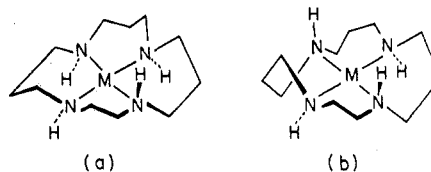

Figure 1. Configurational isomers of planar chelated [15]aneN<sub>4</sub>: (a) isomer I, (b) isomer II.

The ring size preference for the two metal ions differs; Ni<sup>II</sup> fits the 15-membered ring best and Co<sup>III</sup> chelates with least strain with the 14-membered ring. At this point the validity of the concept of ideal M-N distances for these ligands begins to find confirmation. The ideal M-N distance changes by 0.1-0.15 Å as the number of ring members in the macrocycle is changed by one (Table II). These differences are less subject to uncertainty than the absolute values of the ideal M-N distance. Consideration of a substantial array of experimental data derived from X-ray structure determinations<sup>26</sup> indicates that the normal length of the high-spin Ni<sup>II</sup>-nitrogen bond is in the range between 2.05 and 2.15 Å. In comparison, X-ray data<sup>30</sup> suggest that the normal Co<sup>3+</sup>-nitrogen bond length lies between 1.93 and 2.03 Å. Thus, the high-spin Ni<sup>2+</sup>-N distance is some 0.1 to 0.15 Å larger than the Co<sup>3+</sup>-N distance. This is essentially the difference in the ideal M-N distance between two macrocycles that differ from each other in ring size by one ring member. It is therefore most salutary for the conformational model that the spectrochemical results presented above show that the Ni<sup>2+</sup> fits the 15-membered ring best while Co<sup>3+</sup> is most easily accommodated by the smaller 14-membered ring. In a detailed study,<sup>28</sup> it has been shown that the deviation of  $Dq^{xy}$  from its normal value correlates directly with the mismatch between the ideal M-N distance for the ring and the usual M-N distance for the metal ion.

The isomers of *trans*-[Co([15-16]aneN<sub>4</sub>)Cl<sub>2</sub>]<sup>+</sup> provide interesting illustrations of the intricate stereochemistries of macrocyclic complexes having saturated nitrogen donors. Stereochemical analyses have been reported earlier on a number of such systems.<sup>21,31-34</sup> Figure 1 contains a representation of the ligand structures in the *trans* isomers of the [15]aneN<sub>4</sub> complex. These structures were deduced on the basis of their relative stabilities, modes of synthesis, <sup>13</sup>C NMR spectra, and strain-energy calculations.<sup>28</sup>

Having deduced structures for isomers I and II of *trans*-Co([15]aneN<sub>4</sub>)Cl<sub>2</sub><sup>+</sup>, it was possible to calculate ideal M-N distances for them (Table II). It is particularly satisfying that the value of the ideal M-N distance calculated for isomer II is less than that for the more stable isomer so that the data for the two isomers conforms to the  $Dq^{xy}$  correlation. A similar treatment leads to the rational assignments of configurations to the two isomers of *trans*-Co([16]aneN<sub>4</sub>)Cl<sub>2</sub><sup>+</sup>.<sup>28</sup>

Examples of  $Dq^z$  values for the nickel(II) complexes are summarized in Table I. The usual spectrochemical

(30) Y. Saito, "Spectroscopy and Structure of Metal Chelate Compounds", K. Nakamoto and P. J. McCarthy, Ed., Wiley, New York, N.Y., 1968.

(31) L. G. Warner and D. H. Busch, *J. Am. Chem. Soc.*, **91**, 4092 (1969).

(32) E. Ochiai and D. H. Busch, *Inorg. Chem.*, **8**, 1474 (1969).

(33) T. Ito and D. H. Busch, *J. Am. Chem. Soc.*, **95**, 7528 (1973).

(34) L. G. Warner and D. H. Busch, "Coordination Chemistry-Papers Presented in Honor of John C. Bailar, Jr.", S. Kirschner, Ed., Plenum Press, New York, N.Y., 1969, p 1.

series occurs (NCS > N<sub>3</sub> > Cl > Br). However,  $Dq^{xy}$  shows a substantial dependence on the axial ligand field. For a given macrocyclic ligand, the value of  $Dq^{xy}$  decreases as  $Dq^z$  increases. Similarly, a reciprocal dependence of  $Dq^z$  on  $Dq^{xy}$  is shown. This *cis effect* demonstrates the way in which a macrocyclic ligand field may affect the binding and, by implication, the reactivity of other bound ligands.<sup>26</sup>

The capability to alter the ligand fields of common donors (for a given metal ion) by stereochemical means has broad significance, including the provisions of a foundation stone for the understanding of the behavior of metal ions in biological systems. The entatic hypothesis, as applied to metal-dependent enzymes by Williams and Vallee, suggests that distortions in the ligand fields exerted on metal ions by common donors may facilitate the functionings of the metal ion.<sup>35</sup> Clearly, the ability of a metal ion to electrophilically distort a substrate could be enhanced by the presence of an abnormally weak ligand field. The ligand field variations summarized above provide an adequate demonstration that such a behavior is fundamentally possible. It should be noted that, though the planar tetradentate macrocyclic structure has provided the confirming example, that particular geometry is by no means required for such effects to occur. It is merely necessary that the ligand field be so distorted that the normal metal-donor interaction is not permitted. It is reasonable to question why such distorted and, on the one hand, weakened ligand fields should lead to complex formation in competition with other ligands that might be available.<sup>16</sup> This aspect of the subject is considered further below.

The role of ring size in natural systems is more obvious in the facts that the macrocycles of the heme proteins and chlorophyll, which must accommodate the ions of iron and magnesium, contain 16 ring members while that of vitamin B<sub>12</sub>, which contains cobalt, has 15 members. The common M-N distance in the former is 2.0 Å,<sup>36,37</sup> while that of the latter is ~1.9 Å.<sup>38</sup>

Pioneering quantitative studies by Margerum and associates have extended the qualitative observation (see introduction) that certain tetraaza macrocycles greatly immobilize metal ions. Working with copper(II) ion and the saturated ligands of Curtis (structure VIII),

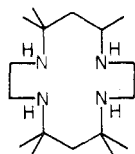

VIII

those investigators showed that the rates of dissociation are diminished by as much as a factor of 10<sup>7</sup> when compared to linear tetradentate ligands.<sup>39</sup> It has also been shown that the rates of formation of the complexes are exceptionally low.<sup>39-41</sup> Other related studies have

(35) B. L. Vallee and R. J. P. Williams, *Proc. Natl. Acad. Sci. U.S.A.*, **59**, 498 (1968).

(36) J. L. Hoard, "Hemes and Hemoproteins", B. Chance, R. W. Estebrook, and T. Yonetani, Ed., Academic Press, New York, N.Y., 1966, p 9.

(37) E. B. Fleischer, *Acc. Chem. Res.*, **3**, 105 (1970).

(38) H. A. O. Hill, "Inorganic Biochemistry", G. L. Eichhorn, Ed., Elsevier, London, Amsterdam, 1973, p 1076, Table 1.

(39) D. K. Cabbiness and D. W. Margerum, *J. Am. Chem. Soc.*, **92**, 2151 (1970).

Table III  
Rates of Dissociation of Ni([13-16]aneN<sub>4</sub>)<sup>2+</sup> in 0.3 M Aqueous HClO<sub>4</sub>, μ = 0.5 M, 25 °C

ligands	k, s <sup>-1</sup>
[13]aneN <sub>4</sub>	2.0 × 10 <sup>-5</sup>
[14]aneN <sub>4</sub>	<i>a</i>
[15]aneN <sub>4</sub>	6.4 × 10 <sup>-5</sup>
[16]aneN <sub>4</sub>	1.9 × 10 <sup>-1</sup>

<sup>a</sup> Under these conditions the solutions are stable for many months.

been carried out on complexes of tetraaza macrocycles; however, none have clearly shown the effects of ring size.<sup>42-46</sup>

Rorabacher and associates studied a series of tetraaza macrocycles<sup>47</sup> strictly analogous to the tetraaza macrocycles of structures III through VII, but extending from 12 through 18 members. The metal ion chosen for the studies was Cu<sup>II</sup>, and the data reported were obtained on 80% methanol solutions. When compared to complexes of linear tetradentate ligands, those of macrocyclic ligands again showed exceptional stabilities, traceable to retarded rates of dissociation. A strong dependence of dissociation rate on ring size was observed, while the rate of formation showed only a weak dependence. It might be conjectured that rings fitting the metal ion relatively well are associated with minimum dissociation rates since the smaller rings were found to dissociate more slowly. Ring size effects in these systems are partially obscured by questions relating to the geometries in which these ligands coordinate. It is doubtful that the smaller rings, especially the 12-membered ring, can encircle the metal ion.<sup>16,48</sup> The principal message nonetheless comes through clearly: macrocyclic ligands greatly immobilize metal ions, and reciprocally, the ligands are greatly immobilized by the metal ions. Further, the effects are both kinetic and thermodynamic.

The results of unpublished studies carried out in these laboratories in collaboration with Daniel Leussing, Ludmilla Martin, and Robert Callahan clarify the relationship between ring size and the critical rate of dissociation. The ligands [13-16]aneN<sub>4</sub> all encircle the metal ion, and the studies described above provide a clear demonstration that high-spin Ni<sup>II</sup> fits the [15]-aneN<sub>4</sub> with least strain.<sup>26</sup> In aqueous solution only the 15- and 16-membered rings yield high-spin Ni<sup>II</sup>, while the 13- and 14-membered rings lead to low-spin, square-planar Ni<sup>II</sup>. An examination of X-ray data on low-spin Ni<sup>II</sup> complexes with saturated nitrogen donors reveals that this species is essentially the same size as low-spin Co<sup>III</sup>. It follows that [14]aneN<sub>4</sub> fits low-spin Ni<sup>II</sup> best. Thus the tetraaza systems at hand provide two pairs of species to compare: low-spin Ni([13-

(40) C. Lin, D. B. Rorabacher, G. R. Cayley, and D. W. Margerum, *Inorg. Chem.*, **14**, 919 (1975).

(41) W. Steinmann and T. A. Kaden, *Helv. Chim. Acta*, **58**, 1358 (1975), and references therein.

(42) D. K. Cabbiness and D. W. Margerum, *J. Am. Chem. Soc.*, **91**, 6540 (1969).

(43) F. P. Hinz and D. W. Margerum, *J. Am. Chem. Soc.*, **96**, 4993 (1974); F. P. Hinz and D. W. Margerum, *Inorg. Chem.*, **13**, 2941 (1974).

(44) A. Dei and R. Gori, *Inorg. Chim. Acta*, **14**, 157 (1975).

(45) L. Hertli and T. A. Kaden, *Chimia*, **29**, 304 (1975).

(46) F. Wagner, M. T. Mocella, M. J. D'Aniello, Jr., A. H. Wang, and E. K. Barefield, *J. Am. Chem. Soc.*, **96**, 2625 (1974).

(47) T. E. Jones, L. L. Zimmer, L. L. Diaddario, and D. B. Rorabacher, *J. Am. Chem. Soc.*, **97**, 7163 (1975).

(48) M. Kodama and E. Kimura, *J. Chem. Soc., Chem. Commun.*, **326**, 891 (1975).

$14[\text{janeN}_4]^{2+}$  and high-spin  $\text{Ni}([\text{15-16}]\text{janeN}_4)(\text{H}_2\text{O})_2^{2+}$ . The reaction of interest is shown by eq 2, and the

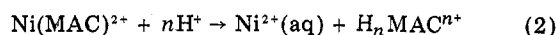

hydrogen ion dependence provides complications in detailed comparisons. However, the rates of dissociation measured under identical conditions provide an appropriate indication of the relative labilities of the complexes. The data of Table III show that the ligand that fits the metal ion best ( $[\text{15}]\text{janeN}_4$  in the high-spin case and  $[\text{14}]\text{janeN}_4$  in the low-spin case) dissociates most slowly. In the case of the 14-membered-ring derivative, no noticeable dissociation occurs under the specific conditions stated in Table III over a period of many months, implying a half-life of years. Allowing an additional factor for this, the total range spanned by the complexes with macrocyclic ligands is at least eight orders of magnitude (pseudo-first-order rate constants,  $\text{s}^{-1}$ ). For the high-spin case the ring that fits in the least strained fashion is removed at a rate of some  $10^4$  less than the more strained ring.

Macrocyclic ligands tend to immobilize metal ions, and the macrocyclic ligands that fit metal ions well immobilize them very greatly. The magnitude of this metal ion-ligand immobilization is highly significant in two ways. First, in favorable cases the extent of the immobilization is astounding; second, the immobilization requires only four sites on the metal ion. The latter consideration is most meaningful when it is applied to such natural species as the iron porphyrin prosthetic group of the heme proteins. Since the hydrated ions of iron are required by equilibrium considerations to precipitate as rust from aqueous solutions at a pH of 7 in the presence of oxygen, the necessity for strong chelation in natural iron complexes is obvious. The fact that the macrocyclic porphyrin can accomplish this while still having two coordination sites available on the iron is of great importance. In most cases at least one of these axial sites is used to bind the prosthetic group to a functional group from the protein, while the remaining axial coordination position may be the site for interaction between the metal ion and a substrate, e.g.,  $\text{O}_2$  in the case of hemoglobin and myoglobin.

Some years ago, prior to the quantitative elaboration of this metal ion immobilization, it was pointed out that such effects are well illustrated by complexes of macrocyclic ligands but that they should not be restricted to such structures.<sup>16</sup> Many arrangements of donor atoms in chelating ligands can be envisioned in which the donors are so arranged that a simple stepwise dissociation process is thwarted by stereochemical constraints. Such structures are well illustrated by the 1,3,5-triaminocyclohexane complex of  $\text{Ni}^{\text{II}}$  which has been shown by Wentworth and Childers to dissociate very slowly,<sup>49</sup> and by the bidentate sparteine complexes of ions such as  $\text{Cu}^{\text{II}}$  and  $\text{Ni}^{\text{II}}$  which are also dilatory in their dissociation reactions.<sup>50</sup> This effect may account for the adequate binding of metal ions in enzymic coordination sites where the entatic hypothesis, as described earlier, requires weakened metal-donor interaction. That is, ligands having propitious geometries may greatly immobilize metal ions while leaving them in short supply of electron density.

(49) R. F. Childers and R. A. D. Wentworth, *Inorg. Chem.*, **8**, 2218 (1969).

(50) E. Boschmann, L. M. Weinstock and M. Carmack, *Inorg. Chem.*, **13**, 1297 (1974); Y. Hung, Ph.D. Thesis, The Ohio State University, 1976.

Table IV  
Rate Constants<sup>51</sup> for the Aquation of Complexes of the Form  $\text{trans-Co}^{\text{III}}([\text{13-16}]\text{janeN}_4)\text{Cl}_2^+$

L	$k_1$ (at 25 °C), $\text{s}^{-1}$
$[\text{13}]\text{janeN}_4$	$6.76 \times 10^{-4}$
$[\text{14}]\text{janeN}_4^a$	$1.1 \times 10^{-6}$
$[\text{15}]\text{janeN}_4$ (isomer I)	$1.16 \times 10^{-3}$
$[\text{15}]\text{janeN}_4$ (isomer II)	$9.92 \times 10^{-3}$
$[\text{16}]\text{janeN}_4$ (isomer I)	2.57

<sup>a</sup> C. K. Poon and M. L. Tobe, *J. Chem. Soc. A*, 2069 (1967).

There are probably relatively few reactions in coordination chemistry so well studied as the aquation of the halopentaamines and dihalotetraamines of cobalt(III). The details of the processes are somewhat complicated, but it may be concluded that bond-breaking is of primary importance in forming the transition states for these reactions. The cis effect observed in studies on the electronic spectra of *trans*-diacido tetradentate macrocyclic ligand complexes suggested the possibility that the aquation rates of the complexes  $\text{trans-Co}([\text{13-16}]\text{janeN}_4)\text{Cl}_2^+$  might be sensitive to ring size. Consequently, these processes have been subjected to detailed study.<sup>51</sup> All initial reactions proceed with retention of *trans* geometry and ligand configuration and can be represented by eq 3.

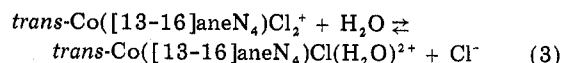

Kinetic data for these processes is summarized in Table IV.

The mechanisms of aquation of chloro amines of cobalt(III) are essentially  $\text{S}_{\text{N}}1$  in character,<sup>52</sup> so that one might expect to predict the sequence of aquation rates for  $\text{trans-Co}([\text{13-16}]\text{janeN}_4)\text{Cl}_2^+$  on the basis of the spectrochemical cis effect described earlier. For complexes with macrocycles of varying ring size,  $Dq^2$  increases as the ring size increases. By inference, this is also the sequence in which the Co-Cl bond strength increases. It follows that, if the variation in rate is determined by the ease of bond-breaking, the  $[\text{13}]\text{janeN}_4$  complex should aquate most rapidly and the  $[\text{16}]\text{janeN}_4$  most slowly. Two results are immediately obvious from the rates given in Table IV: the effect of ring size on rate is very large, spanning a range of more than five orders of magnitude, from  $2.6 \text{ s}^{-1}$  to  $1.1 \times 10^{-6} \text{ s}^{-1}$  at 25 °C. The second most obvious result is that the sequence stands in strong contradiction to that predicted on the basis of spectrochemical parameters. It is actually more nearly opposite to the prediction but still more complicated, for the rate does not vary in a monotonic fashion with ring size (or ideal M-N distance). The sequence shows a minimum at  $\text{trans-Co}([\text{14}]\text{janeN}_4)\text{Cl}_2^+$ , and the value of  $k$  for that case at 25 °C is slower than that for the much studied complex  $\text{trans-Co}(\text{en})_2\text{Cl}_2^+$  ( $3.2 \times 10^{-5} \text{ s}^{-1}$ ).<sup>53</sup> The other macrocyclic ligand derivatives all aquate more rapidly. The fact that the aquation rate for  $\text{trans-Co}([\text{13-16}]\text{janeN}_4)\text{Cl}_2^+$  exhibits a minimum in the case of the 14-membered ring derivative finds a parallel in the

(51) Y. Hung and D. H. Busch, *J. Am. Chem. Soc.*, **99**, 4977 (1977), and reference therein.

(52) F. Basolo and R. G. Pearson, "Mechanisms of Inorganic Reactions", Wiley, New York, N.Y., 1967, and references therein.

(53) M. E. Baldwin, S. C. Chan, and M. L. Tobe, *J. Chem. Soc.*, 4637 (1961).

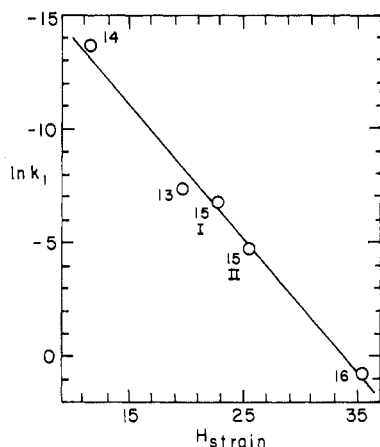

Figure 2. Correlation of strain energy with  $\ln k_1$  for the aquation of  $\text{trans-Co}([13-16]\text{aneN}_4)\text{Cl}_2^+$ , 25 °C, 0.1 M  $\text{HNO}_3$ .

strain energy values given in Table II.

The change in rate of aquation with ring size exhibits two especially meaningful features. For all rings except [14]aneN<sub>4</sub> the aquation rate is accelerated when compared to that of the familiar complex  $\text{trans-Co}(\text{en})_2\text{Cl}_2^+$  and the rates parallel the strain energies of the complexes. Figure 2 shows that the correlation between aquation rate and strain energy is quite good. Therefore we look to the strain energy to understand how ring size affects the aquation rates of the complexes  $\text{trans-Co}([13-16]\text{aneN}_4)\text{Cl}_2^+$ .

Strain energies are a theoretical property of the starting complexes in the gas phase, while rate constants reflect the free-energy differences between the starting complexes and the corresponding transition state species. The fact that the change in a property of the starting material correlates with the variation in rates suggests that this property is either the same for all the transition-state species or the magnitude of the property is negligible at the transition state. It is rational to conclude that the strain energies of the complexes are relieved in the transition state.

A simple model rationalizes these relationships. The starting cobalt(III) complexes are stereochemically rigid, inert complexes and the macrocyclic ligand is locked into its conformation regardless of the magnitude of the strain energy. The aquation reactions of the halo amines of cobalt(III) proceed by a mechanism that is essentially  $\text{S}_{\text{N}}1$  in character.<sup>52</sup> In forming the transition state, bond-breaking between the leaving halide and the metal ion is of principal importance. In the limiting mechanism, the complex could be represented as an ion pair between a 5-coordinate cobalt(III) species and the departing chloride ion, as shown in eq 4. Removal of

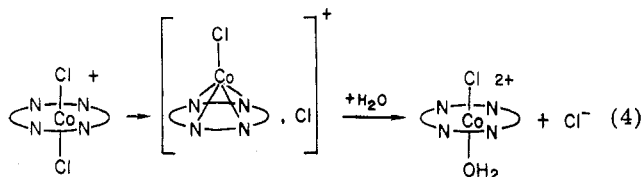

one  $\text{Cl}^-$  to enhanced separation from the cobalt atom and its encircling macrocycle provides the possibility for the relief of strain energy. Equation 4 represents this situation, showing the metal ion displaced somewhat above the plane of the coordinated nitrogen atoms. This mode of relief of strain energy should be effective for rings that are undersized as compared to the best-fit

Table V  
Half-Wave Potentials<sup>a</sup> for the  $\text{Co}^{\text{III}}/\text{Co}^{\text{II}}$  Couple in  
 $\text{Co}([13-16]\text{aneN}_4)\text{Cl}_2^+$

complex	$E_{1/2}$ , V	$\Delta p$ , mV <sup>b</sup>
$\text{trans-Co}([13]\text{aneN}_4)\text{Cl}_2^+$	-0.66	90
$\text{trans-Co}([14]\text{aneN}_4)\text{Cl}_2^+$	-0.69	70
$\text{trans}(I)\text{-Co}([15]\text{aneN}_4)\text{Cl}_2^+$	-0.38	93
$\text{trans}(II)\text{-Co}([15]\text{aneN}_4)\text{Cl}_2^+$	-0.47	160
$\text{trans}(I)\text{-Co}([16]\text{aneN}_4)\text{Cl}_2^+$	-0.15	~150
$\text{trans}(II)\text{-Co}([16]\text{aneN}_4)\text{Cl}_2^+$	-0.11	150

<sup>a</sup> Rotating platinum electrode, 600 rpm, in acetonitrile vs.  $\text{Ag}/\text{AgNO}_3$  (0.1 M) reference electrode, 0.1 M  $\text{Bu}_4\text{NBF}_4$  as supporting electrolyte. <sup>b</sup> Cyclic voltammetry, scan rate 500 mV s<sup>-1</sup>, stationary platinum electrode.

macrocyclic. Larger rings may rearrange in a more complex manner in order to relieve the strain energy characteristic of the starting complex. The significant conclusion is that removal of one  $\text{Cl}^-$  and formation of the five-coordinate intermediate permit each ring to relax into a less strained chelated conformation.

The results summarized above provide a revealing demonstration of the presumably general influence of strain energy on the rates of substitution reactions at metal ion centers. Here it has been concluded that strain associated with the chelation to a metal ion may lead to a great increase in the rates of dissociation of a different ligand from the same metal ion. As was suggested above for other dramatic effects that were first understood among complexes with macrocyclic ligands, this phenomenon need not be restricted to complexes with that class of ligands. Indeed, if rapid dissociation were necessary for the monodentate ligands binding to a metal ion at the active site in an enzyme, then excess strain energy might provide the triggering force.

Earlier studies<sup>54,55</sup> have shown that the potential for the  $\text{Co}^{\text{III}}/\text{Co}^{\text{II}}$  couple is not sensitive to modest variations in the in-plane ligand field while it is quite sensitive to variations in the axial ligand field. This is especially significant in view of the variations in  $E_{1/2}$  with ring size for the first reduction step for the complexes  $\text{trans-Co}([13-16]\text{aneN}_4)\text{Cl}_2^+$  (Table V).<sup>28</sup> The values change in the sequence [13] > [14] < [15] < [16] and the total range spans about 600 mV.  $E_{1/2}$  correlates with strain energy (correlation coefficient, 0.88) in the same manner as shown earlier for the rates of aquation of the same complexes. Thus, the electrochemical change, which relates to a difference in a physical property for the cobalt(III) and cobalt(II) complexes, correlates with the strain energy of the cobalt(III) complexes. This suggests that the strain energy is largely relieved in the cobalt(II) complexes. This is consistent, in turn, with the well-known lability and distorted structures for complexes of cobalt(II).

Since the pioneering work of Olson and Vasilevskis<sup>56</sup> it has been evident that macrocyclic ligands facilitate the generation of oxidation states that are unusual for a given combination of metal ion and donor atoms. The  $\text{Ni}^{2+}/\text{Ni}^{3+}$  couple is considered here because it has been studied extensively.<sup>57-59</sup> The potential of the  $\text{Ni}^{\text{III}}/\text{Ni}^{\text{II}}$

(54) D. P. Rillema, J. F. Endicott, and E. Papaconstantinou, *Inorg. Chem.*, 10, 1739 (1971).

(55) A. M. Tait, F. V. Lovecchio, and D. H. Busch, *Inorg. Chem.*, 16, 2206 (1977).

(56) D. C. Olson and J. Vasilevskis, *Inorg. Chem.*, 8, 1611 (1969); 10, 463 (1971).

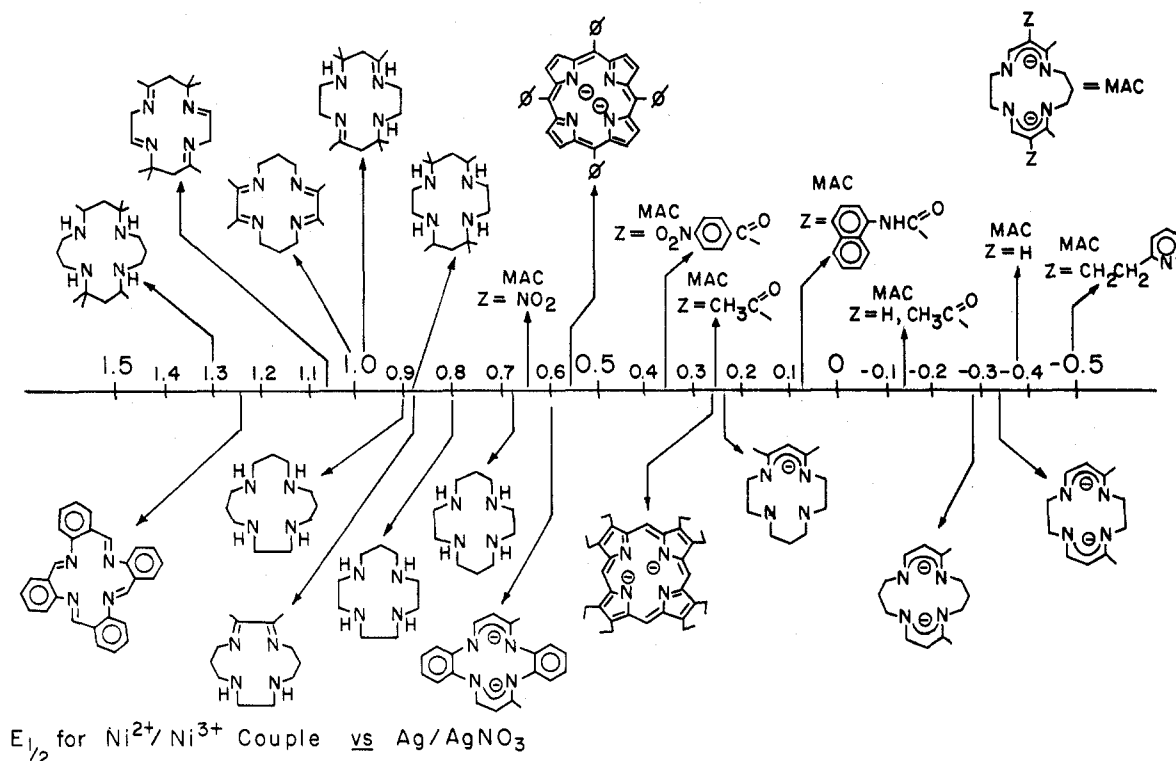
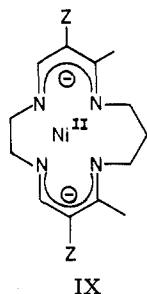

Figure 3.  $E_{1/2}$  for the  $Ni^{2+}/Ni^{3+}$  couple in tetraaza macrocyclic complexes vs.  $Ag/AgNO_3$ , 0.1 M, reference electrode in  $CH_3CN$ .<sup>59</sup>

couple may be varied over a range of at least 1.8 V by changes in the structure of the tetraaza macrocycle.<sup>57,59</sup> This is shown in Figure 3, where most of the data were obtained under identical conditions (acetonitrile,  $Ag/AgNO_3$ , 0.1 M, reference electrode, 0.1 M  $Bu_4NBF_4$  supporting electrolyte, rotating platinum electrode, 600 rpm).<sup>59</sup> In many cases, the presence of the  $Ni^{3+}$  has been established by ESR measurements.<sup>57</sup> These data illustrate the wide-ranging control that can be exerted on potentials by subtle and cumulative variations in ligand structure. The particular advantage that has been found with macrocyclic ligands is the opportunity to vary ligand structure in a fashion that is incremental and produce species having potentials that are predictable from additivity relationships. This has been shown most clearly for the  $Ni^{2+}/Ni^{3+}$  couple.<sup>57,59</sup> Similar behavior has been found for the  $Fe^{2+}/Fe^{3+}$ <sup>59,60</sup> and  $Co^{1+}/Co^{2+}$ <sup>55,59</sup> couples.

Substituents have been used to control the potential of the  $Ni^{2+}/Ni^{3+}$  couple in planar complexes with dianionic ligands (structure IX).<sup>59,61</sup> Table VI shows that



(57) F. V. Lovecchio, E. S. Gore, and D. H. Busch, *J. Am. Chem. Soc.*, **96**, 3109 (1974).

(58) E. S. Gore and D. H. Busch, *Inorg. Chem.*, **12**, 1 (1973).

(59) D. H. Busch, D. G. Pillsbury, F. V. Lovecchio, A. M. Tait, Y. Hung, S. Jackels, M. C. Rakowski, W. P. Schammel, and L. Y. Martin, *ACS Symp. Ser.*, **No. 30**, 32 (1977).

(60) J. C. Dabrowiak, F. V. Lovecchio, V. L. Goedken, and D. H. Busch, *J. Am. Chem. Soc.*, **94**, 5502 (1972).

Table VI  
Half-Wave Potentials for  $Ni^{2+}/Ni^{3+}$  in Complexes of Dianionic Ligands of Structure IX<sup>59,61</sup> Having Different Substituents (Z), in Dimethylformamide Solutions,  $Ag/AgNO_3$  (0.1 M) Reference Electrode, 0.1 M  $n-Bu_4NBF_4$  Supporting Electrolyte

Substituent	Oxidation, <sup>a</sup> $E_{1/2}$ , V	d-d Band, $\gamma$ , $10^3 \text{ cm}^{-1}$ (e)
$-CH_2CH_2COOC_2H_5$	-0.39	17.02 (224)
-H	-0.36 i	17.15 (169)
$CH_3CO-$ ; -H	-0.14 i	18.32 (197)
$-CONH-\alpha-C_{10}H_7$	+0.03	18.66 (285)
$-COC_6H_5$	+0.21	19.27 (433)
$-COCH_3$	+0.22	19.30 (330)
$-NO_2$	+0.42	19.80 (922)

$E_{1/2}$  may be caused to range over some 0.8 V in this way. These data correlate very well with Hammett  $\sigma$  values, showing that the electron density change on the ligand is transmitted directly to the metal ion (correlation coefficient, 0.99+).

The strong control over metal ion electrode potentials by variations in structural parameters should have substantial utility in the design of catalytic systems and in the mimicking of natural systems.

## Conclusions

The development of broad families of synthetic macrocyclic ligands has both produced new metal compounds of interest in their own right and made it possible to elucidate the special advantages that accrue to complexes containing macrocyclic ligands. Macrocyclic ligand structures facilitate control of the chemical and physical properties of metal ions to a remarkable extent. The ligand field strengths of macrocyclic ligands having common donors (e.g., N, O) can be controlled by the match or mismatch between the intra-

(61) D. G. Pillsbury and D. H. Busch, *J. Am. Chem. Soc.*, **98**, 7836 (1976).



ring site size and the normal metal-donor distance. Variations in the interactions between the donors of the macrocycle and the metal ion are accompanied by changes in the bonding interaction between the metal ion and axial monodentate ligands—a cis effect. For saturated tetraaza macrocycles a conformational strain energy model has been developed to explain these ligand field effects. Strain energy effects also influence the labilities of both the macrocyclic ligand and the axial monodentate ligands in complexes of macrocyclic ligands. In general, the cyclic ligand structure stabilizes the metal-macrocycle complex in both the thermodynamic and the kinetic sense, with the latter effect being the greater. Rings that fit specific metal ions will result in extreme immobilization. Redox potentials also reflect strain energy effects. Because of the great immobilization of macrocyclic complexes, oxidation states that have been considered to be rare are often easily produced. By varying macrocyclic ligand

structure, the potential of a given metal ion couple can be varied over extreme ranges ( $\sim 2$  V) within a given fixed stereochemistry (square planar) and with a constant set of donor atoms (four nitrogens).

The principles revealed in the study of complexes of macrocyclic ligands have a number of broad areas of application. They provide a basis for rationalizing some of the seemingly unusual behaviors of metal ions in natural products such as heme proteins and metal-containing enzymes (e.g., the entatic hypothesis). They should be applicable to complexes of other ligand types in addition to macrocycles, and they provide the basis for tailoring metal complexes for use in certain areas of catalysis or as models for biochemical processes.

*The work summarized herein is that of my former graduate students and postdoctoral associates. Their names appear in the reference cited. The financial support of the National Institutes of Health and the National Science Foundation is gratefully acknowledged.*